

1 2 3 4 5

A TUNER CIRCUIT

A
B
C
D
E
F

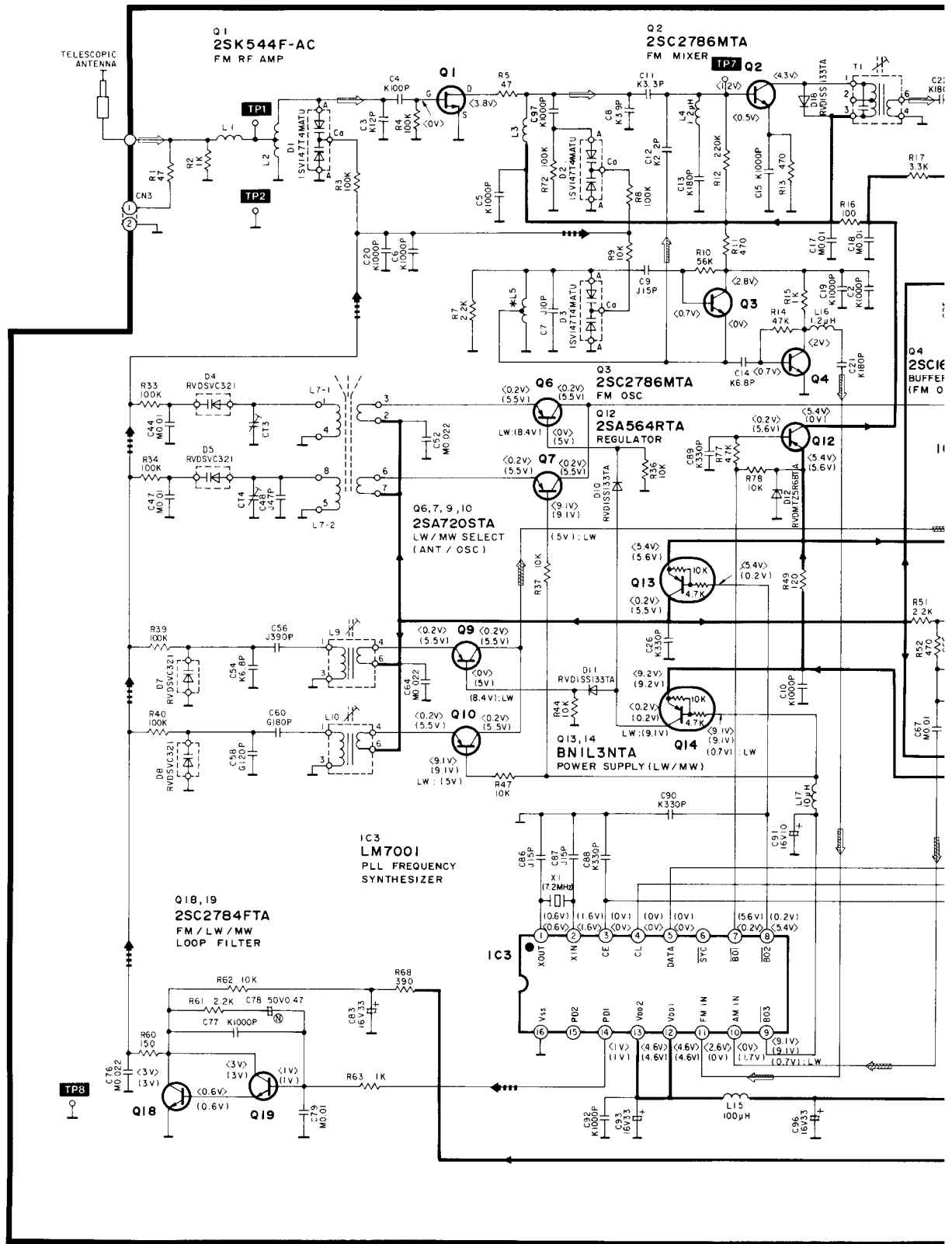

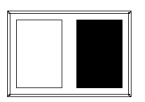
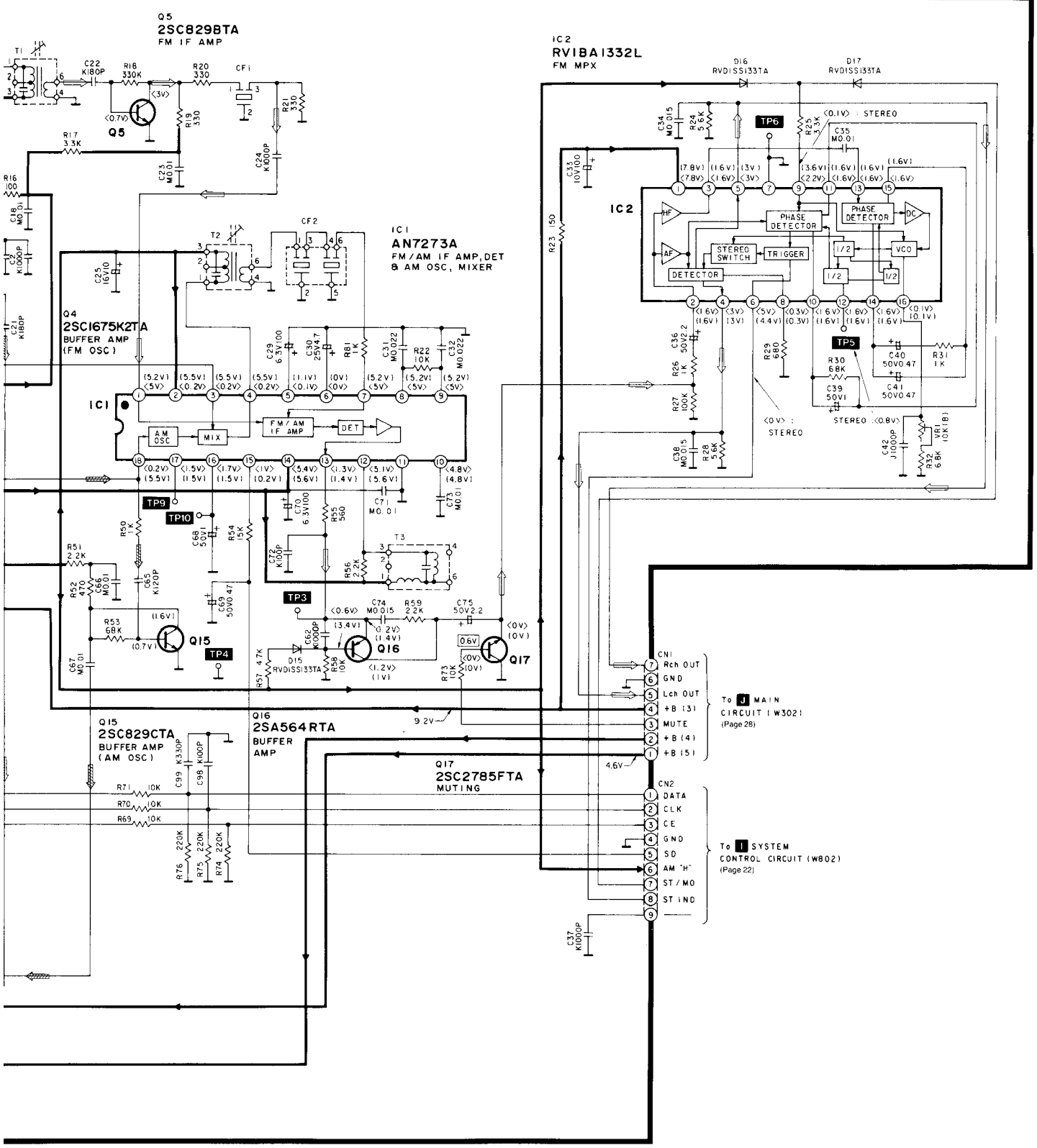

1 2 3 4 5

A

B

C

D

E

F

B MAIN CIRCUIT

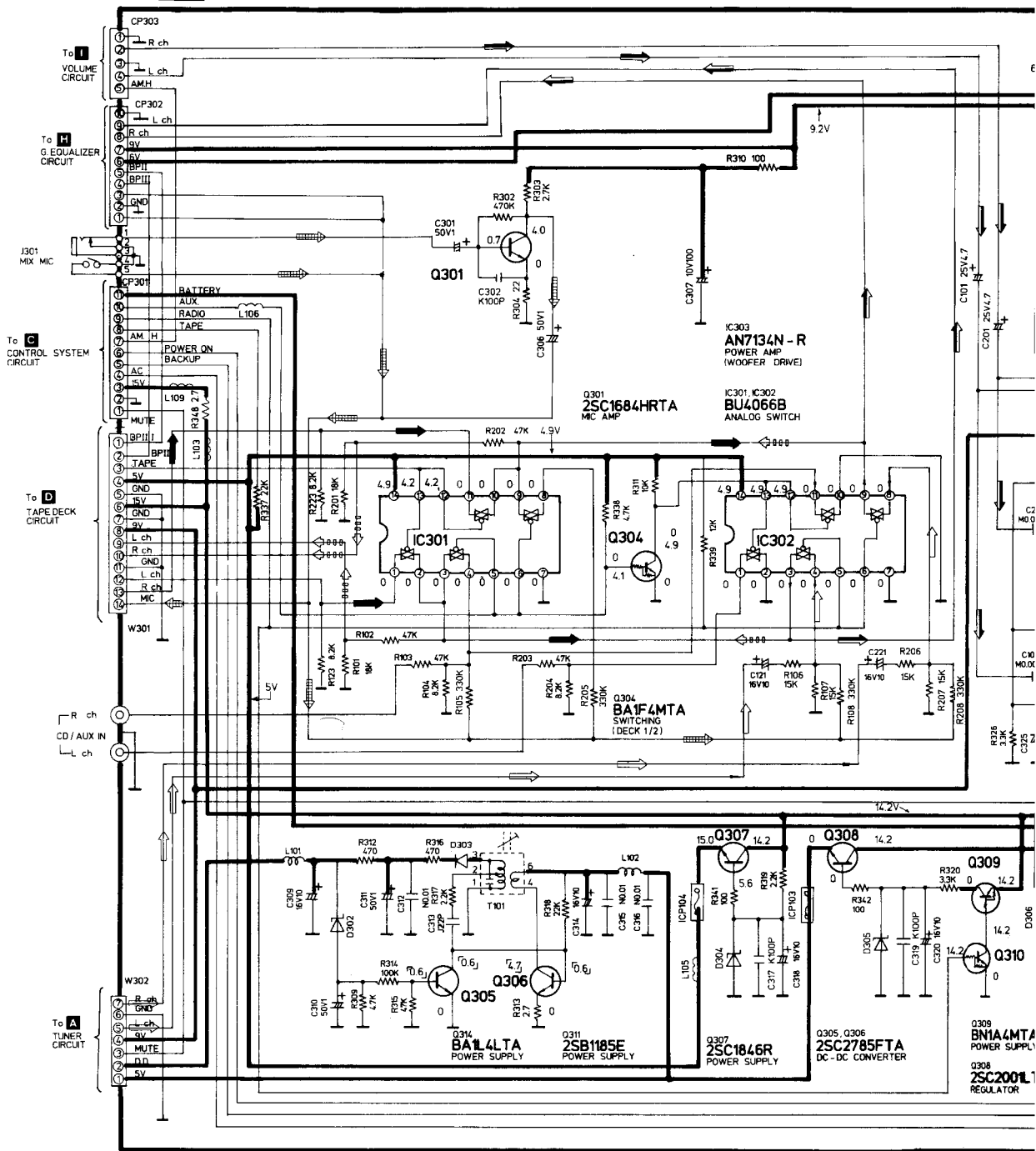

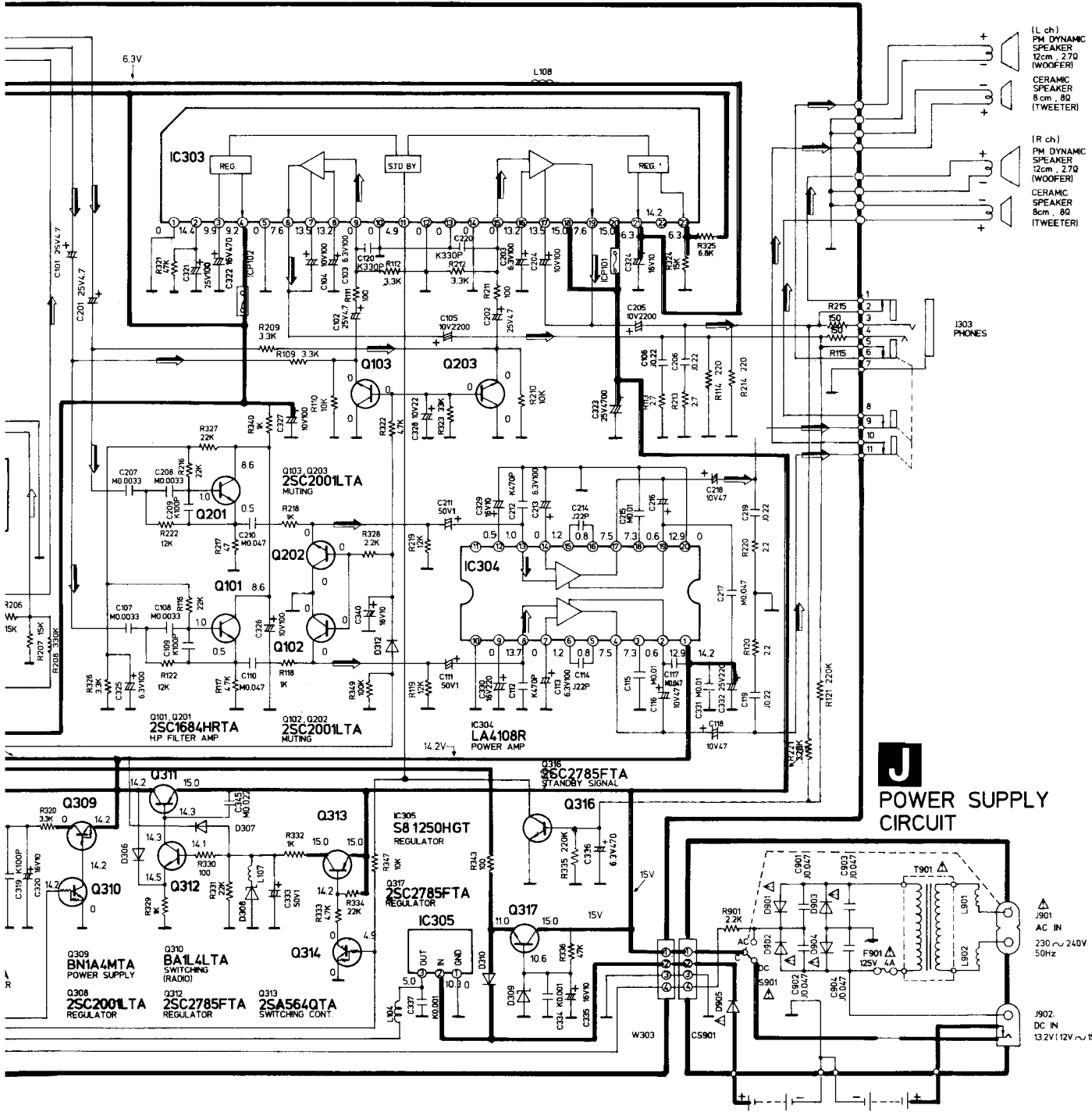

(L ch)
PM DYNAMIC
SPEAKER
12cm . 27Ω
(WOOFER)
CERAMIC
SPEAKER
8cm . 8Ω
(TWEETER)

(R ch)
PM DYNAMIC
SPEAKER
12cm . 27Ω
(WOOFER)
CERAMIC
SPEAKER
8cm . 8Ω
(TWEETER)

J
**POWER SUPPLY
CIRCUIT**

MEMORY BACK-UP
FOR COMPUTER CLOCK
(BATTERY 4 "AA" SIZE
BATTERIES 6V)

MAIN
FOR COMPUTER CLOCK
(BATTERY 10 "D" SIZE
BATTERIES 15V)



LED BLOCK

C SYSTEM CONTROL CIRCUIT

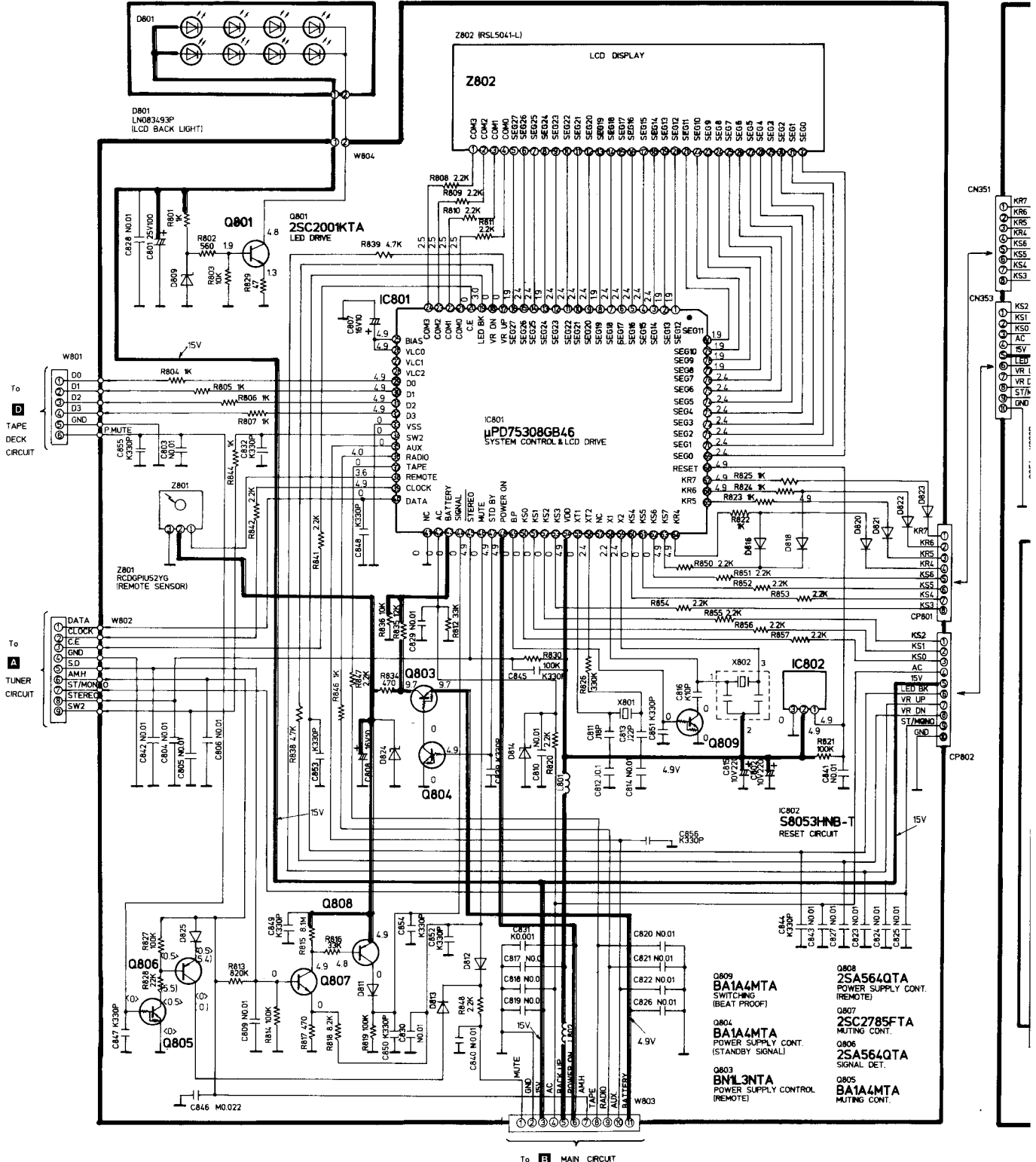

To B MAIN CIRCUIT



H G. EQUALIZER CIRCUIT

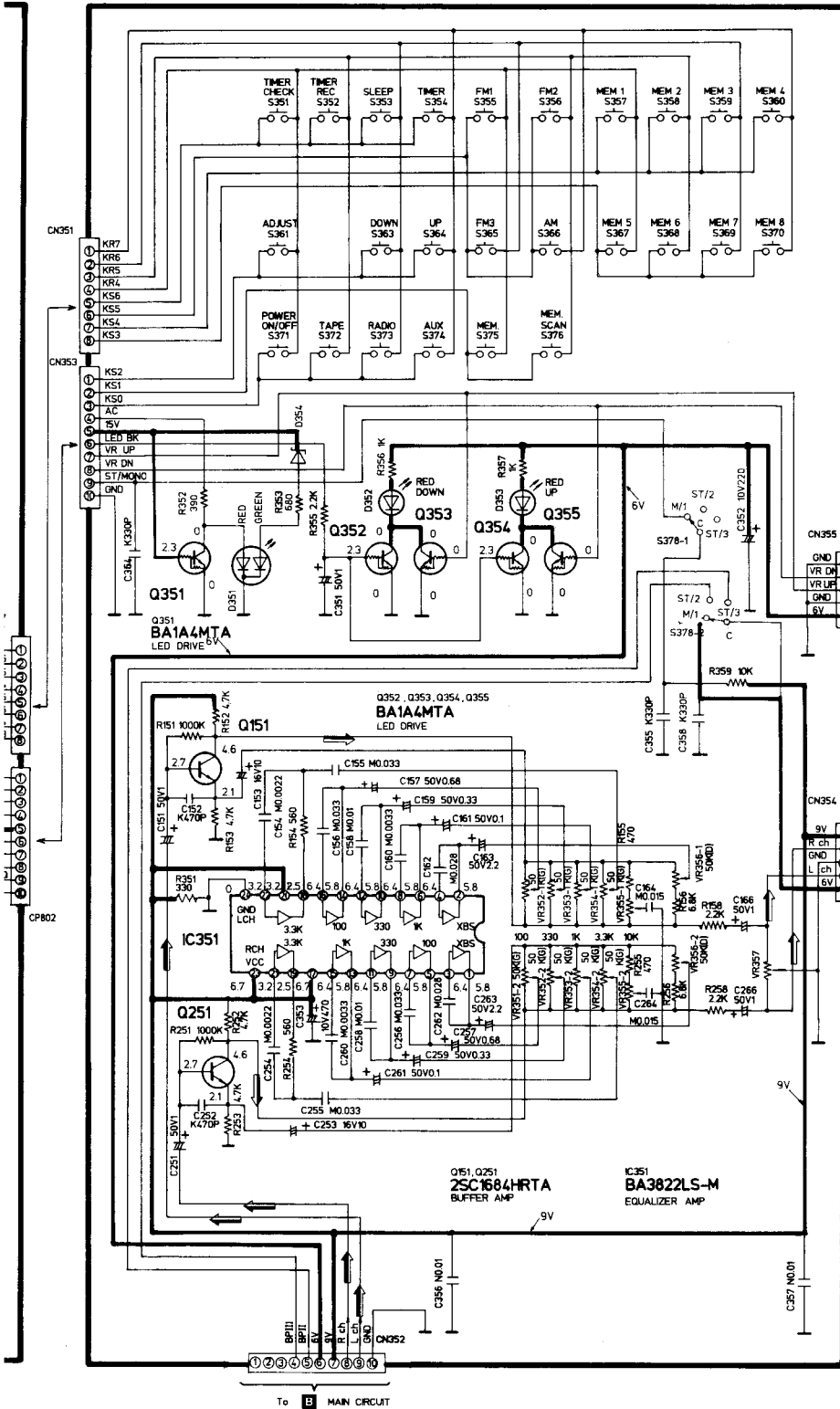

D TAPE DECK CIRCUIT

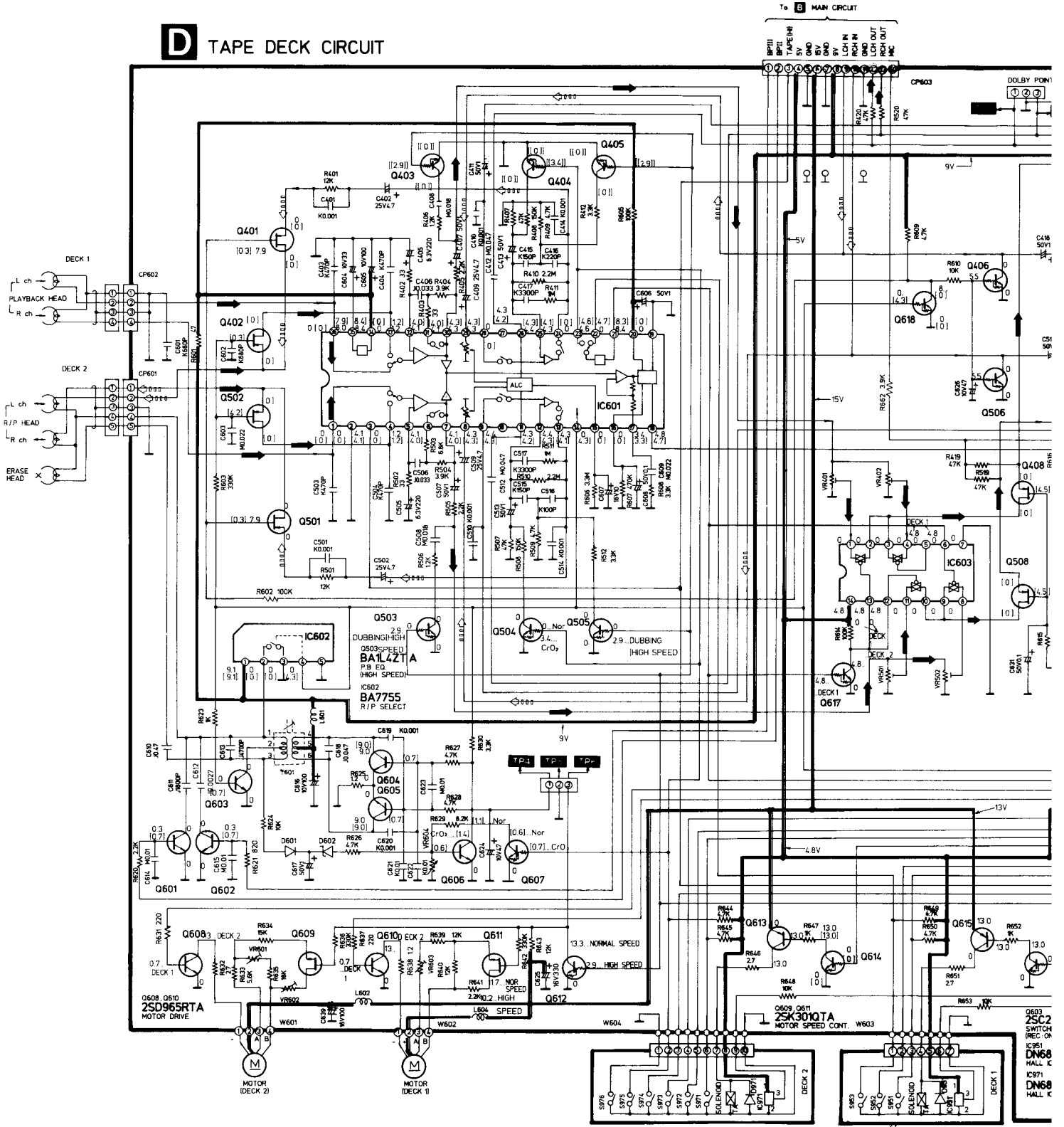

MECHANISM(DECK 2) CIRCUIT

MECHANISM(DECK 1) C

E

F

